

## DS-2CD3143G2-ISU 4 MP AcuSense Fixed Dome Network Camera

### AcuSense



Hikvision has been dedicated to develop products with security since established.

Hikvision always follows security by design principle and has adopted many methods of security technologies into our product development lifecycle, including terminal security, data security, application security, network security, and privacy protection.

In the meantime, the security technologies used by Hikvision are all in compliance with local applicable laws and safety regulations. These security measures could enhance product's cyber security protection capability and protect your devices as well as your data from malicious cyber attacks.

- High quality imaging with 4 MP resolution
- Efficient H.265+ compression technology
- Clear imaging against strong back light due to 120 dB true WDR technology
- Focus on human and vehicle classification based on deep learning
- Built-in arrayed dual-microphone for real-time high quality audio security
- Water and dust resistant (IP67) and vandal-resistant (IK10)

## ▪ Specification

| Camera                 |  |
|------------------------|--|
| Image Sensor           | 1/2.9" Progressive Scan CMOS   |
| Max. Resolution        | 2688 × 1520  |
| Min. Illumination      | Color: 0.005 Lux @ (F1.6, AGC ON), B/W: 0 Lux with IR  |
| Shutter Time           | 1/3 s to 1/100,000 s   |
| Day & Night            | IR cut filter  |
| Angle Adjustment       | Pan: 0° to 355°, tilt: 0° to 75°, rotate: 0° to 355°   |
| Lens                   |  |
| Lens Type              | Fixed focal lens, 2.8, 4, and 6 mm optional  |
| Focal Length & FOV     | 2.8 mm, horizontal FOV 103.6°, vertical FOV 57.2°, diagonal FOV 121.6°<br>4 mm, horizontal FOV 83.5°, vertical FOV 44.8°, diagonal FOV 99.9°<br>6 mm, horizontal FOV 51.8°, vertical FOV 27.9°, diagonal FOV 60.5° |
| Lens Mount             | M12  |
| Aperture               | F1.6   |
| Iris Type              | Fixed  |
| Depth of Field         | 2.8 mm: 1.4 m to ∞<br>4 mm: 1.5 m to ∞<br>6 mm: 3.5 m to ∞   |
| DORI                   |  |
| DORI                   | 2.8 mm, D: 63 m, O: 25 m, R: 12 m, I: 6 m<br>4 mm, D: 78 m, O: 31 m, R: 15 m, I: 7 m<br>6 mm, D: 128 m, O: 50 m, R: 25 m, I: 12 m  |
| Illuminator            |  |
| Supplement Light Range | Up to 40 m   |
| Smart Supplement Light | Yes  |
| IR Wavelength          | 850 nm   |
| Supplement Light Type  | IR   |
| Video                  |  |
| Main Stream            | 50 Hz:<br>25 fps (2688 × 1520, 1920 × 1080, 1280 × 720)<br>60 Hz:<br>30 fps (2688 × 1520, 1920 × 1080, 1280 × 720)   |
| Sub-Stream             | 50 Hz:<br>25 fps (1280 × 720, 640 × 480, 640 × 360)<br>60 Hz:<br>30 fps (1280 × 720, 640 × 480, 640 × 360)   |
| Third Stream           | 50 Hz:<br>10 fps (1920 × 1080, 1280 × 720, 640 × 480, 640 × 360)<br>60 Hz:<br>10 fps (1920 × 1080, 1280 × 720, 640 × 480, 640 × 360)<br>*Third stream is supported under certain settings.                         |

|                             |  |
|-----------------------------|--|
| Fourth Stream               | 50 Hz:<br>10 fps (1280 × 720, 640 × 480, 640 × 360)<br>60 Hz:<br>10 fps (1280 × 720, 640 × 480, 640 × 360)<br>*Fourth stream is supported under certain settings.  |
| Video Compression           | Main stream: H.265/H.264/H.264+/H.265+,<br>Sub-stream: H.265/H.264/MJPEG,<br>Third stream: H.265/H.264,<br>Fourth stream: H.265/H.264/MJPEG<br>*Third stream and fourth stream are supported under certain settings.             |
| Video Bit Rate              | 32 Kbps to 8 Mbps  |
| H.264 Type                  | Baseline Profile/Main Profile/High Profile   |
| H.265 Type                  | Main Profile   |
| Scalable Video Coding (SVC) | H.264 and H.265 encoding   |
| Bit Rate Control            | CBR, VBR   |
| Region of Interest (ROI)    | 5 fixed regions for main stream and sub-stream   |
| Target Cropping             | Yes  |
| <b>Audio</b>                |  |
| Audio Compression           | G.711/G.722.1/G.726/MP2L2/PCM/MP3/AAC-LC   |
| Audio Bit Rate              | 64 Kbps (G.711ulaw/G.711alaw)/16 Kbps (G.722.1)/16 Kbps (G.726)/32 to 192 Kbps (MP2L2)/8 to 320 Kbps (MP3)/16 to 64 Kbps (AAC-LC)  |
| Audio Sampling Rate         | 8 kHz/16 kHz/32 kHz/48 kHz   |
| Environment Noise Filtering | Yes  |
| <b>Network</b>              |  |
| Protocols                   | TCP/IP, ICMP, HTTP, HTTPS, FTP, DHCP, DNS, DDNS, RTP, RTSP, RTCP, NTP, UPnP, SMTP, IGMP, 802.1X, QoS, IPv4, IPv6, UDP, Bonjour, SSL/TLS, PPPoE, SNMP, WebSocket, WebSockets  |
| Simultaneous Live View      | Up to 6 channels   |
| API                         | ONVIF (Profile S, Profile G), ISAPI, SDK, ISUP   |
| User/Host                   | Up to 32 users<br>3 user levels: administrator, operator, and user   |
| Security                    | Password protection, complicated password, HTTPS encryption, IP address filter, Security Audit Log, basic and digest authentication for HTTP/HTTPS, TLS 1.1/1.2, WSSE and digest authentication for Open Network Video Interface |
| Client                      | iVMS-4200, Hik-Connect, Hik-Central  |
| Network Storage             | NAS (NFS, SMB/CIFS), Auto Network Replenishment (ANR),<br>Together with high-end Hikvision memory card, memory card encryption and health detection are supported.   |
| Web Browser                 | Plug-in required live view: IE11,<br>Plug-in free live view: Chrome 80+, Firefox 80+, Edge 89+, Safari 13+,<br>Local service: Chrome 80+, Firefox 80+, Edge 89+, Safari 13+  |
| <b>Image</b>                |  |
| Privacy Mask                | 8 programmable polygon privacy masks   |
| Image Parameters Switch     | Yes  |
| Day/Night Switch            | Day, Night, Auto, Schedule   |
| SNR                         | ≥ 52 dB  |

|                                  |   |
|----------------------------------|---|
| Image Enhancement                | BLC, HLC, 3D DNR  |
| Wide Dynamic Range (WDR)         | 120 dB  |
| <b>Interface</b>                 |   |
| Ethernet Interface               | 1 RJ45 10 M/100 M self-adaptive Ethernet port   |
| On-Board Storage                 | Built-in memory card slot, support microSD/microSDHC/microSDXC card, up to 512 GB   |
| Audio                            | Built-in Microphone: Arrayed dual-microphone<br>1 input (line in), max. input amplitude: 3.3 Vpp, input impedance: 4.7 K $\Omega$ , interface type: non-equilibrium;<br>1 output (line out), max. output amplitude: 3.3 Vpp, output impedance: 100 $\Omega$ , interface type: non-equilibrium   |
| Alarm                            | 1 input, 1 output (max. 12 VDC, 30 mA)  |
| Reset Key                        | Yes   |
| <b>Event</b>                     |   |
| Basic Event                      | Motion detection (support alarm triggering by specified target types (human and vehicle)), video tampering alarm, exception   |
| Smart Event                      | Unattended baggage detection, object removal detection, loitering detection, people gathering detection, people running detection, parking detection, video quality diagnosis   |
| Linkage                          | Upload to FTP/NAS/memory card, notify surveillance center, send email, trigger alarm output, trigger recording, trigger capture   |
| <b>Deep Learning Function</b>    |   |
| Perimeter Protection             | Line crossing, intrusion, region entrance, region exiting<br>Support alarm triggering by specified target types (human and vehicle)   |
| Face Capture                     | Yes   |
| <b>General</b>                   |   |
| Material                         | Base: aluminum alloy, cover: aluminum alloy   |
| Dimension                        | $\varnothing$ 121.5 mm $\times$ 97.6 mm ( $\varnothing$ 4.78" $\times$ 3.84")   |
| Package Dimension                | 150 mm $\times$ 150 mm $\times$ 141 mm (5.9" $\times$ 5.9" $\times$ 5.6")   |
| Weight                           | Approx. 600 g (1.3 lb.)   |
| With Package Weight              | Approx. 826 g (1.8 lb.)   |
| Storage Conditions               | -30 $^{\circ}$ C to 60 $^{\circ}$ C (-22 $^{\circ}$ F to 140 $^{\circ}$ F). Humidity 95% or less (non-condensing)   |
| Startup and Operating Conditions | -30 $^{\circ}$ C to 60 $^{\circ}$ C (-22 $^{\circ}$ F to 140 $^{\circ}$ F). Humidity 95% or less (non-condensing)   |
| Power                            | 12 VDC $\pm$ 25%, 0.7 A, max. 8.4 W, $\varnothing$ 5.5 mm coaxial power plug, reverse polarity protection,<br>PoE: IEEE 802.3af, Class 3, max. 10 W   |
| Language                         | 33 languages: English, Russian, Estonian, Bulgarian, Hungarian, Greek, German, Italian, Czech, Slovak, French, Polish, Dutch, Portuguese, Spanish, Romanian, Danish, Swedish, Norwegian, Finnish, Croatian, Slovenian, Serbian, Turkish, Korean, Traditional Chinese, Thai, Vietnamese, Japanese, Latvian, Lithuanian, Portuguese (Brazil), Ukrainian |
| General Function                 | Heartbeat, mirror, flash log, password reset via email, pixel counter, anti-banding   |
| <b>Approval</b>                  |   |
| EMC                              | CE-EMC: EN 55032:2015+A1:2020, EN 50130-4:2011+A1:2014, EN IEC 61000-3-2:2019+A1:2021, EN 61000-3-3:2013+A1:2019+A2:2021,<br>RCM: AS/NZS CISPR 32: 2015,<br>IC: ICES-003: Issue 7   |

|             |  |
|-------------|--|
| Safety      | UL: UL 62368-1,<br>CB: IEC 62368-1: 2014+A11,<br>CE-LVD: EN 62368-1: 2014/A11: 2017,<br>BIS: IS 13252 (Part 1): 2010/IEC 60950-1: 2005,<br>LOA: IEC/EN 60950-1 |
| Environment | CE-RoHS: 2011/65/EU,<br>WEEE: 2012/19/EU,<br>Reach: Regulation (EC) No 1907/2006   |
| Protection  | IP67: IEC 60529-2013, IK10: IEC 62262:2002   |

## ▪ Typical Application

Hikvision products are classified into three levels according to their anti-corrosion performance. Refer to the following description to choose for your using environment.

This model has NO SPECIFIC PROTECTION

| Level                  | Description  |
|------------------------|--|
| Top-level protection   | Hikvision products at this level are equipped for use in areas where professional anti-corrosion protection is a must. Typical application scenarios include coastlines, docks, chemical plants, and more.   |
| Moderate protection    | Hikvision products at this level are equipped for use in areas with moderate anti-corrosion demands. Typical application scenarios include coastal areas about 2 kilometers (1.24 miles) away from coastlines, as well as areas affected by acid rain. |
| No specific protection | Hikvision products at this level are equipped for use in areas where no specific anti-corrosion protection is needed.  |

## ▪ Available Model

DS-2CD3143G2-ISU(6mm)

DS-2CD3143G2-ISU(2.8mm)(B)

DS-2CD3143G2-ISU(4mm)(B)

DS-2CD3143G2-ISU(6mm)(B)





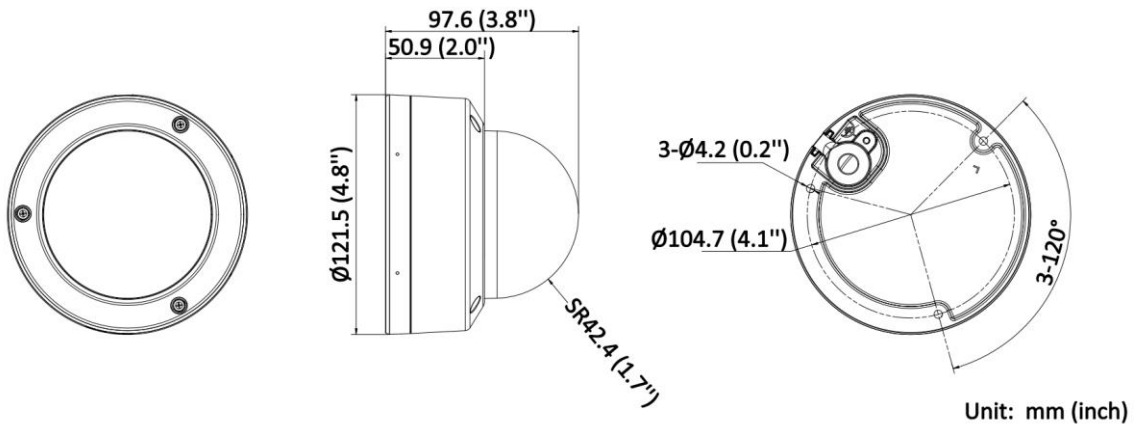



DS-2CD3143G2-ISU(2.8mm)(B)(Black)

▪ **Dimension**



▪ **Accessory**

▪ **Optional**

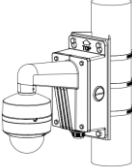
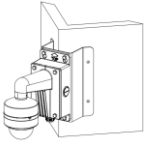
| DS-1272ZJ-120<br>Wall mount   | DS-1272ZJ-120B<br>Wall mount  | DS-1271ZJ-120<br>Pendant Mount  | DS-1275ZJ-SUS<br>Vertical pole mount  | DS-1276ZJ-SUS<br>Corner mount   |
|---|---|---|---|---|
|  |  |  |  |  |
|  |  |  |  |  |

| DS-1280ZJ-DM46<br>Junction box  | DS-2280ZJ-WA120<br>Junction box   | DS-2210ZJ-WA-120<br>Pendant Mount   | DS-2200ZJ-WA-120<br>Wall mount  | DS-2200ZJ-WAJ-120<br>Wall mount   |
|---|---|---|---|---|
|  |  |  |  |  |
|  |  |  |  |  |

**Headquarters**

No.555 Qianmo Road, Binjiang District,  
Hangzhou 310051, China  
T +86-571-8807-5998  
www.hikvision.com



Follow us on social media to get the latest product and solution information.

