

## DS-2CD2143G2-LI(S)(2U)

4 MP Acusense Smart Hybrid Light Fixed Dome Network Camera



- High quality imaging with 4 MP resolution
- Acusense: Focus on human and vehicle classification based on deep learning
- Smart Hybrid Light: Integrates IR and White lights, 4 supplemental lighting modes
- -2U: Built-in arrayed dual-microphone for real-time high quality audio security
- Clear imaging against strong back light due to 120 dB true WDR technology
- Efficient H.265+ compression technology
- Water and dust resistant (IP67) and vandal-resistant (IK10)

## ▪ Specification

| Camera                      |  |
|-----------------------------|--|
| Image Sensor                | 1/2.9" Progressive Scan CMOS   |
| Max. Resolution             | 2688 × 1520  |
| Min. Illumination           | Color: 0.005 Lux @ (F1.6, AGC ON), B/W: 0 Lux with light   |
| Shutter Time                | 1/3 s to 1/100,000 s   |
| Day & Night                 | IR cut filter  |
| Angle Adjustment            | Pan: 0° to 355°, tilt: 0° to 75°, rotate: 0° to 355°   |
| Lens                        |  |
| Lens Type                   | Fixed focal lens, 2.8 and 4 mm optional  |
| Focal Length & FOV          | 2.8 mm, horizontal FOV 104°, vertical FOV 57°, diagonal FOV 122°<br>4 mm, horizontal FOV 84°, vertical FOV 45°, diagonal FOV 100°  |
| Lens Mount                  | M12  |
| Iris Type                   | Fixed  |
| Aperture                    | F1.6   |
| Depth of Field              | 2.8 mm: 1.4 m to ∞<br>4 mm: 1.5 m to ∞   |
| DORI                        |  |
| DORI                        | 2.8 mm, D: 63 m, O: 25 m, R: 12 m, I: 6 m<br>4 mm, D: 78 m, O: 31 m, R: 15 m, I: 7 m   |
| Illuminator                 |  |
| Supplement Light Type       | IR, White Light  |
| Supplement Light Range      | Up to 30 m   |
| Smart Supplement Light      | Yes  |
| IR Wavelength               | 850 nm   |
| Video                       |  |
| Main Stream                 | 50 Hz:<br>25 fps (2688 × 1520, 1920 × 1080, 1280 × 720)<br>60 Hz:<br>30 fps (2688 × 1520, 1920 × 1080, 1280 × 720)   |
| Sub-Stream                  | 50 Hz: 25 fps (1280 × 720, 640 × 480, 640 × 360)<br>60 Hz: 30 fps (1280 × 720, 640 × 480, 640 × 360)   |
| Third Stream                | 50 Hz: 10 fps (1920 × 1080, 1280 × 720, 640 × 480, 640 × 360)<br>60 Hz: 10 fps (1920 × 1080, 1280 × 720, 640 × 480, 640 × 360)<br>*Third stream is supported under certain settings. |
| Video Compression           | Main stream: H.265/H.264/H.264+/H.265+,<br>Sub-stream: H.265/H.264/MJPEG,<br>Third stream: H.265/H.264,<br>*Third stream is supported under certain settings.                        |
| Video Bit Rate              | 32 Kbps to 8 Mbps  |
| H.264 Type                  | Baseline Profile, Main Profile, High Profile   |
| H.265 Type                  | Main Profile   |
| Scalable Video Coding (SVC) | H.264 and H.265 encoding   |
| Bit Rate Control            | CBR, VBR   |
| Region of Interest (ROI)    | 1 fixed region for main stream and sub-stream  |
| Target Cropping             | Yes  |

| <b>Audio</b>                |   |
|-----------------------------|---|
| Audio Compression           | -2U: G.711/G.722.1/G.726/MP2L2/PCM/MP3/AAC-LC   |
| Audio Bit Rate              | -2U: 64 Kbps (G.711ulaw/G.711alaw)/16 Kbps (G.722.1)/16 Kbps (G.726)/32 to 160 Kbps (MP2L2)/8 to 320 Kbps (MP3)/16 to 64 Kbps (AAC-LC)  |
| Audio Sampling Rate         | -2U: 8 kHz/16 kHz/32 kHz/48 kHz   |
| Environment Noise Filtering | -2U: Yes  |
| <b>Network</b>              |   |
| Protocols                   | TCP/IP, ICMP, HTTP, HTTPS, FTP, DHCP, DNS, DDNS, RTP, RTSP, RTCP, NTP, UPnP, SMTP, IGMP, 802.1X, QoS, IPv4, IPv6, UDP, Bonjour, SSL/TLS, PPPoE, SNMP, WebSocket, WebSockets   |
| Simultaneous Live View      | Up to 6 channels  |
| API                         | ONVIF (Profile S, Profile G), ISAPI, SDK, ISUP  |
| Security                    | Password protection, complicated password, HTTPS encryption, IP address filter, Security Audit Log, basic and digest authentication for HTTP/HTTPS, TLS 1.1/1.2/1.3, WSSE and digest authentication for Open Network Video Interface  |
| User/Host                   | Up to 32 users<br>3 user levels: administrator, operator, and user  |
| Network Storage             | NAS (NFS, SMB/CIFS), Auto Network Replenishment (ANR), Together with high-end Hikvision memory card, memory card encryption and health detection are supported.   |
| Client                      | iVMS-4200, Hik-Connect, Hik-Central   |
| Web Browser                 | Plug-in required live view: IE 11,<br>Plug-in free live view: Chrome 80+, Firefox 80+, Edge 89+, Safari 13+,<br>Local service: Chrome 80+, Firefox 80+, Edge 89+, Safari 13+  |
| <b>Image</b>                |   |
| Image Parameters Switch     | Yes   |
| Day/Night Switch            | Day, Night, Auto, Schedule  |
| Wide Dynamic Range (WDR)    | 120 dB  |
| SNR                         | ≥ 52 dB   |
| Image Enhancement           | BLC, HLC, 3D DNR  |
| Privacy Mask                | 8 programmable polygon privacy masks  |
| <b>Interface</b>            |   |
| Ethernet Interface          | 1 RJ45 10 M/100 M self-adaptive Ethernet port   |
| On-Board Storage            | Built-in memory card slot, support microSD/microSDHC/microSDXC card, up to 512 GB   |
| Alarm                       | -S: 1 input, 1 output (max. 12 VDC, 30 mA)  |
| Reset Key                   | Yes   |
| Audio                       | Built-in Microphone:<br>-2U: Arrayed dual-microphone<br><br>-S: 1 input (line in), two-core terminal block, max. input amplitude: 3.3 Vpp, input impedance: 4.7 KΩ, interface type: non-equilibrium<br>1 output (line out), two-core terminal block, max. output amplitude: 3.3 Vpp, output impedance: 100 Ω, interface type: non-equilibrium |
| <b>Event</b>                |   |
| Basic Event                 | Motion detection (support alarm triggering by specified target types (human and vehicle)), video tampering alarm, exception   |

|                                  |   |
|----------------------------------|---|
| Linkage                          | Upload to FTP/NAS/memory card, notify surveillance center, send email, trigger recording, trigger capture, -S: trigger alarm output   |
| <b>Deep Learning Function</b>    |   |
| Perimeter Protection             | Line crossing, intrusion<br>Support alarm triggering by specified target types (human and vehicle)  |
| <b>General</b>                   |   |
| Power                            | 12 VDC $\pm$ 25%, 0.6 A, max. 7.2 W, $\varnothing$ 5.5 mm coaxial power plug, reverse polarity protection,<br>PoE: IEEE 802.3af, Class 3, max. 8.5 W  |
| Material                         | Base: aluminum alloy, cover: aluminum alloy   |
| Dimension                        | $\varnothing$ 121.5 mm $\times$ 97.6 mm ( $\varnothing$ 4.78" $\times$ 3.84")   |
| Package Dimension                | 150 mm $\times$ 150 mm $\times$ 141 mm (5.91" $\times$ 5.91" $\times$ 5.55")  |
| Weight                           | Approx. 600 g (1.3 lb.)   |
| With Package Weight              | Approx. 830 g (1.8 lb.)   |
| Storage Conditions               | -30 °C to 60 °C (-22 °F to 140 °F). Humidity 95% or less (non-condensing)   |
| Startup and Operating Conditions | -30 °C to 60 °C (-22 °F to 140 °F). Humidity 95% or less (non-condensing)   |
| Language                         | 33 languages: English, Russian, Estonian, Bulgarian, Hungarian, Greek, German, Italian, Czech, Slovak, French, Polish, Dutch, Portuguese, Spanish, Romanian, Danish, Swedish, Norwegian, Finnish, Croatian, Slovenian, Serbian, Turkish, Korean, Traditional Chinese, Thai, Vietnamese, Japanese, Latvian, Lithuanian, Portuguese (Brazil), Ukrainian |
| General Function                 | Heartbeat, mirror, flash log, password reset via email, pixel counter, anti-banding   |
| <b>Approval</b>                  |   |
| EMC                              | CE-EMC: EN 55032:2015+A1:2020, EN 50130-4:2011+A1:2014, EN IEC 61000-3-2:2019+A1:2021, EN 61000-3-3:2013+A1:2019+A2:2021,<br>RCM: AS/NZS CISPR 32: 2015,<br>IC: ICES-003: Issue 7,<br>KC: KN32: 2015, KN35: 2015  |
| Safety                           | CB: IEC 62368-1: 2014+A11,<br>CE-LVD: EN 62368-1: 2014/A11: 2017,<br>BIS: IS 13252 (Part 1): 2010/IEC 60950-1: 2005,<br>LOA: IEC/EN 60950-1   |
| Environment                      | CE-RoHS: 2011/65/EU,<br>WEEE: 2012/19/EU,<br>Reach: Regulation (EC) No 1907/2006  |
| Protection                       | IP67: IEC 60529-2013, IK10: IEC 62262:2002  |

## ▪ Typical Application

Hikvision products are classified into three levels according to their anti-corrosion performance. Refer to the following description to choose for your using environment.

This model has NO SPECIFIC PROTECTION

| Level                | Description  |
|----------------------|--|
| Top-level protection | Hikvision products at this level are equipped for use in areas where professional anti-corrosion protection is a must. Typical application scenarios include coastlines, docks, chemical plants, and more. |

|                        |  |
|------------------------|--|
| Moderate protection    | Hikvision products at this level are equipped for use in areas with moderate anti-corrosion demands. Typical application scenarios include coastal areas about 2 kilometers (1.24 miles) away from coastlines, as well as areas affected by acid rain. |
| No specific protection | Hikvision products at this level are equipped for use in areas where no specific anti-corrosion protection is needed.  |

▪ **Available Model**

DS-2CD2143G2-LI(2.8mm)

DS-2CD2143G2-LI(4mm)

DS-2CD2143G2-LIS2U(2.8mm)

DS-2CD2143G2-LIS2U(4mm)





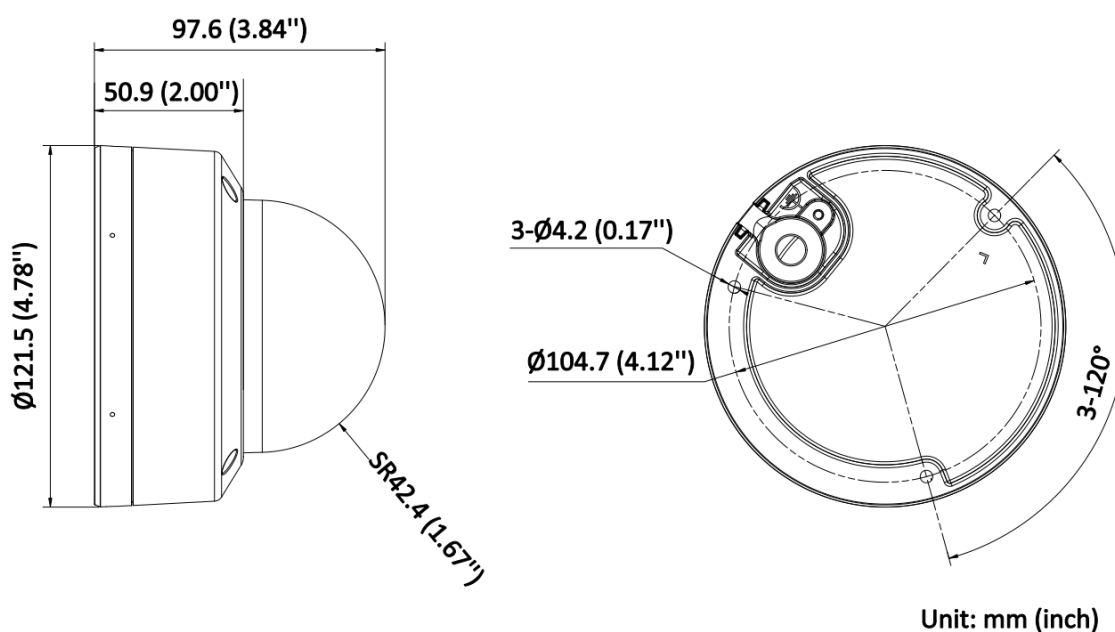











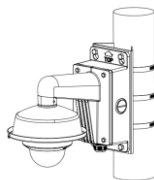
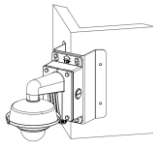

DS-2CD2143G2-LIS2U(2.8mm)(Black)

▪ **Dimension**

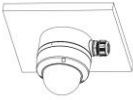
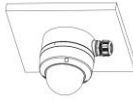

▪ **Accessory**

▪ **Optional**

| DS-1272ZJ-120<br>Wall mount   | DS-1272ZJ-120B<br>Wall mount  | DS-1271ZJ-120<br>Pendant Mount  | DS-1275ZJ-SUS<br>Vertical pole mount  | DS-1276ZJ-SUS<br>Corner mount   |
|---|---|---|---|---|
|    |    |    |    |    |
|    |    |    |     |    |
| DS-1280ZJ-DM46<br>Junction box  | DS-2280ZJ-WA120<br>Junction box   | DS-2210ZJ-WA-120<br>Pendant Mount   | DS-2200ZJ-WA-120<br>Wall mount  | DS-2200ZJ-WAJ-120<br>Wall mount   |
|  |  |  |  |  |
|  |  |  |  |  |

**Headquarters**

No.555 Qianmo Road, Binjiang District,  
Hangzhou 310051, China  
T +86-571-8807-5998  
www.hikvision.com



Follow us on social media to get the latest product and solution information.



Hikvision



HikvisionHQ



HikvisionHQ



Hikvision\_Global



Hikvision  
Corporate Channel



hikvisionhq